

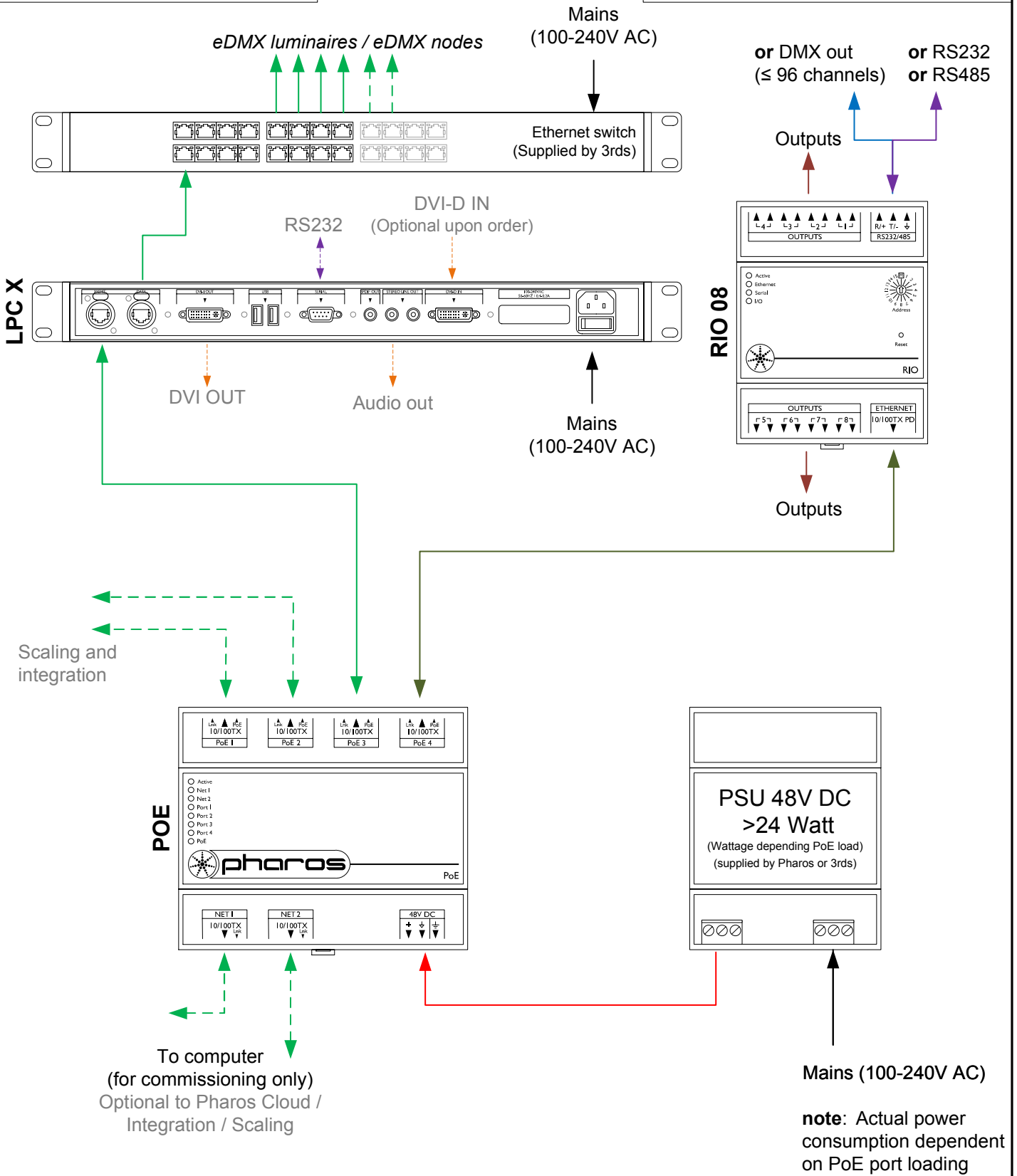

Type:	LPC X (X=10,20,30...100)
eDMX	≤ X * 512 channels
RIO DMX	≤ 96 channels
Total	≤ X * 512 channels

Type:	Inputs	Outputs	Serial Port
RIO 80	8	0	Yes
RIO 44	4	4	Yes
RIO 08	0	8	Yes



- Consult the **Installation Guide** for technical details
- See **General Notes.pdf** for information on cabling types
- **More configurations** are possible to fulfil any project
- Contact your supplier or visit our website for support

 pharoscontrols.com	Reference: 1405	Name: LPC X - RIO 08	
	Size: A4	Date: 27/09/2017	Rev: V 1.0
	Page:	Notes: Setup	
		17/09/2018	V 1.1
		21/01/2019	V 1.2